

€6,10

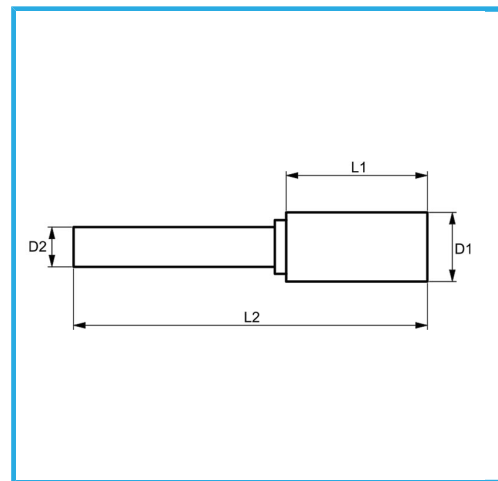

D1	ø3 mm
L1	13 mm
D2	3 mm
L2	65 mm
Dimensioni imballo	13 x 70 x 13 h mm
Peso lordo	0,01 kg
Codice EAN	8012667356712

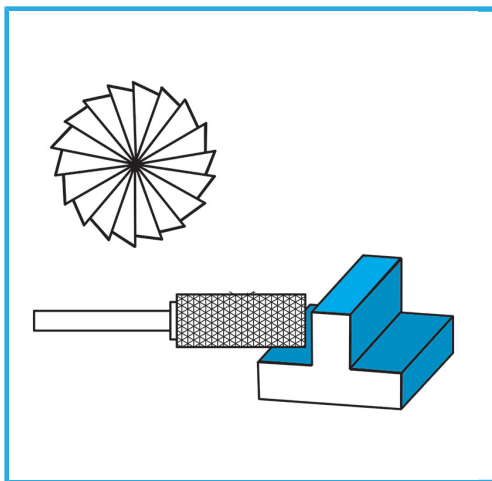

Scatola



HM