

€37,40

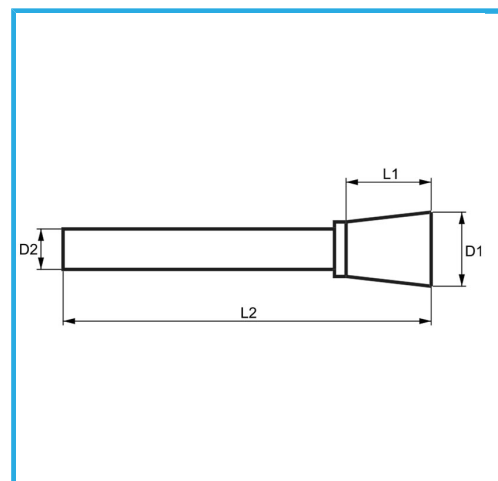

D1	ø16 mm
L1	16 mm
D2	6 mm
L2	58 mm
Dimensioni imballo	100 x 25 x 25 h mm
Peso lordo	0,06 kg
Codice EAN	8012667357917

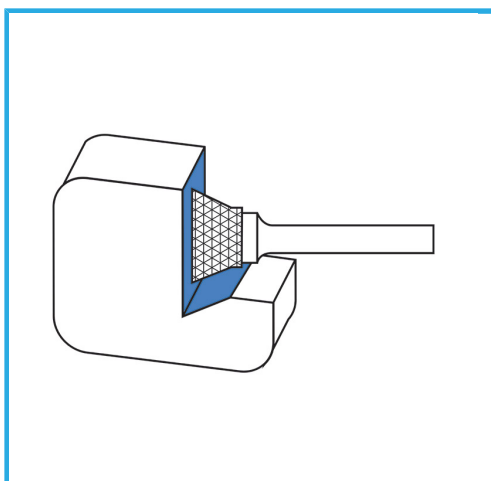

Scatola



HM