

€18,70

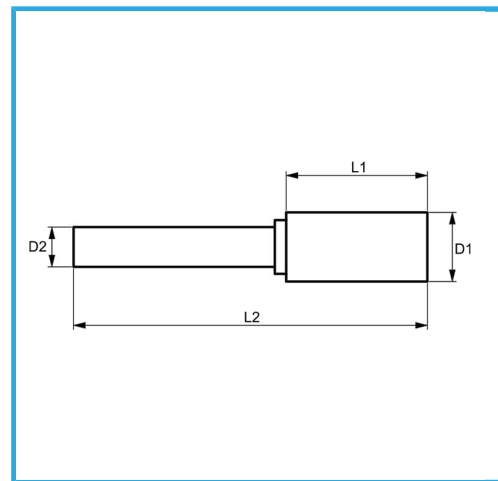

D1	ø8 mm
L1	20 mm
D2	6 mm
L2	120 mm
Dimensioni imballo	21 x 127 x 21 h mm
Peso lordo	0,04 kg
Codice EAN	8012667356729

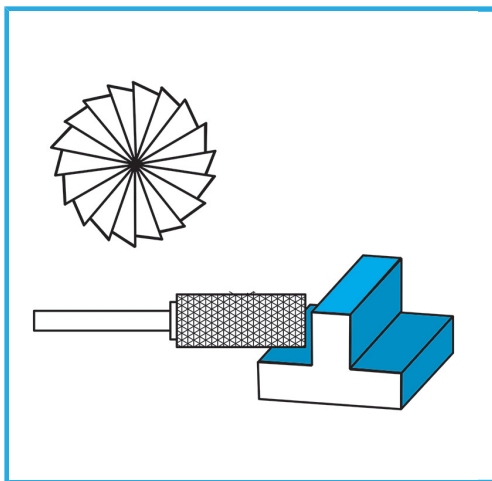

Scatola



HM