

€9,90

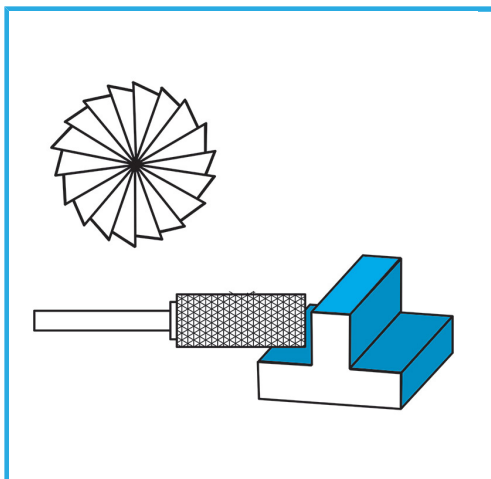

D1	ø4 mm
L1	13 mm
D2	3 mm
L2	41 mm
Dimensioni imballo	13 x 55 x 13 h mm
Peso lordo	0,01 kg
Codice EAN	8012667356477



Scatola



HM

-