

ART. C855/T40
TWO WAY TORX KEY WITH PLASTIC HANDLE

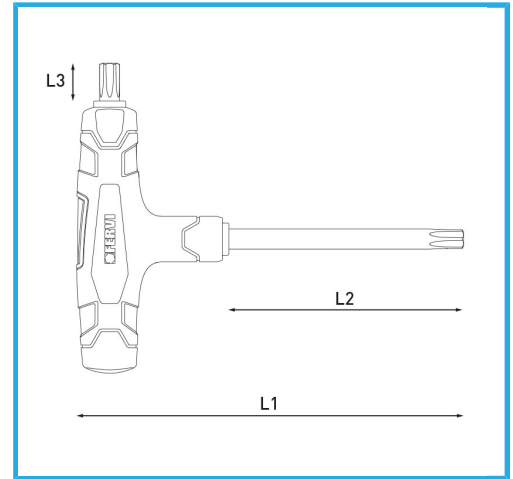

Size	T40
L1	170 mm
L2	100 mm
L3	15 mm
Gross weight	0,14 kg
Packaging dimensions	175 x 140 x 20 h mm
EAN Code	8012667362447



Phosphated



-



Cr-V

-