

CON PUNTA MAGNETICA BRUNITA, IMPUGNATURA IN MATERIALE BICOMPONENTE CON PARTE TERMINALE LIBERA DI RUOTARE PER UN PERFETTO GRIP.

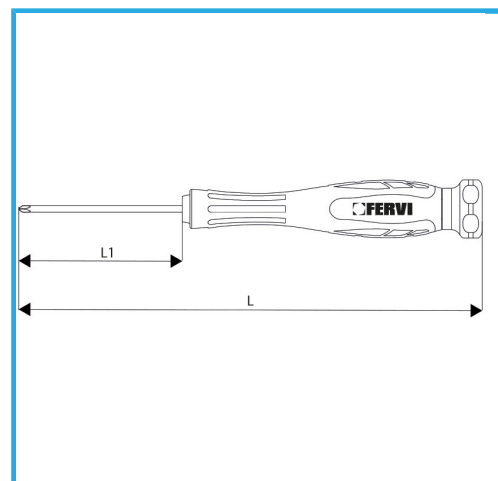

€2,82



Misura	PH 0
Lunghezza asta	50 mm
Lunghezza totale	140 mm
Peso lordo	0,02 kg
Dimensioni imballo	19x19x144h
Codice EAN	8012667349059



Fosfatata



-



Cr-V

-